

Comhairle Cathrach Chorcaí Cork City Council

Halla na Cathrach, Corcaigh - City Hall, Cork - T12 T997

Terence and Jean Canton
Norville,
42 Sydney Park,
Wellington Road,
Cork

07/10/19

**RE: Section 5 Declaration R523/19 42 Sydney Park,
Wellington Road, Cork**

A Chara,

With reference to your request for a Section 5 Declaration at the above named property, I wish to advise as follows:

having regard to —

- Sections 2 and 3 of the *Planning and Development Act 2000* (as amended), and
- Articles 6 and 9 of the *Planning and Development Regulations 2001* (as amended),

It is considered that *the construction of the extension and the shed constructed to the rear of 42 Sidney Park, Wellington Road, Cork* Is Development and Is Exempted Development.

Misa le meas,

Kerry Bergin
Development Management Section
Community, Culture and Placemaking Directorate
Cork City Council



We are Cork.

PLANNER'S REPORT
Ref. R523 /19

Cork City Council
Development Management
Strategic Planning and Economic
Development

Application type	Section 5 Declaration
Description	<i>Whether the construction of a rear extension at the below address is development and if so is it exempted development, and Whether the construction of a shed to the rear of the below address is development and if so if it is exempted development.</i>
Location	42 Sidney Park, Wellington Road, Cork
Applicant	Terence & Jean Canton
Date	17/09/2019
Recommendation	<i>Is Development and Is Exempted Development</i>

In this report 'the Act' means the Planning and Development Act 2000 (as amended) and 'the Regulations' means the Planning and Development Regulations 2001 (as amended), unless otherwise indicated.

1. Further Information Requested

1. A site plan to scale with principle dimensions, including distance to boundary and the width and length of the rear garden, showing the location of the extension and shed that are the subject of this Section 5 Referral.
2. Revised plans showing the extension element to include principle dimensions.
3. Floor plan, elevation and section of the shed.
4. Confirmation that the shed is not used for human habitation.

2. Further Information Provided

The applicant has provided a number of documents and a written statement. It is noted that the specific information, particularly as regarding dimensioned plan for the extension has not been provided. Rather the information regarding the dimensions is provided in a separate written statement.

3. Assessment

The application indicates that the extension to the rear of the property is exempt in accordance with Class 1 of Schedule 2, Article 6 which is:

The extension of a house, by the construction or erection of an extension (including a conservatory) to the rear of the house or by the conversion for use as part of the house of any garage, store, shed or other similar structure attached to the rear or to the side of the house.

The following table will check whether the extension as constructed accords with the conditions and limitations associated with this class of development:

1. (a)	Where the house has not been extended previously, the floor area of any such extension shall not exceed 40 square metres.	Floor area of extension stated to be 13m ² .
1. (b)	Subject to paragraph (a), where the house is terraced or semi-detached, the floor area of any extension above ground level shall not exceed 12 square metres.	n/a
1. (c)	Subject to paragraph (a), where the house is detached, the floor area of any extension above ground level shall not exceed 20 square metres.	n/a

2. (a)	Where the house has been extended previously, the floor area of any such extension, taken together with the floor area of any previous extension or extensions constructed or erected after 1 October 1964, including those for which planning permission has been obtained, shall not exceed 40 square metres.	The cumulative floor area is stated to be less than 40m ² .
2. (b)	Subject to paragraph (a), where the house is terraced or semi-detached and has been extended previously, the floor area of any extension above ground level taken together with the floor area of any previous extension or extensions above ground level constructed or erected after 1 October 1964, including those for which planning permission has been obtained, shall not exceed 12 square metres.	n/a
2. (c)	Subject to paragraph (a), where the house is detached and has been extended previously, the floor area of any extension above ground level, taken together with the floor area of any previous extension or extensions above ground level constructed or erected after 1 October 1964, including those for which planning permission has been obtained, shall not exceed 20 square metres.	n/a
3.	Any above ground floor extension shall be a distance of not less than 2 metres from any party boundary.	The entire extension is at ground level.
4. (a)	Where the rear wall of the house does not include a gable, the height of the walls of any such extension shall not exceed the height of the rear wall of the house.	Walls are below height of rear wall.
4. (b)	Where the rear wall of the house includes a gable, the height of the walls of any such extension shall not exceed the height of the side walls of the house	n/a
4. (c)	The height of the highest part of the roof of any such extension shall not exceed, in the case of a flat roofed extension, the height of the eaves or parapet, as may be appropriate, or, in any other case, shall not exceed the height of the highest part of the roof of the dwelling.	Roof does not exceed the height of the eaves.
5.	The construction or erection of any such extension to the rear of the house shall not reduce the area of private open space, reserved exclusively for the use of the occupants of the house, to the rear of the house to less than 25 square metres.	The remaining open space to the rear of the dwelling is stated to be 76m ² .
6. (a)	Any window proposed at ground level in any such extension shall not be less than 1 metre from the boundary it faces.	All windows in the extension are over 1 metre from any boundary they face.

6. (b)	Any window proposed above ground level in any such extension shall not be less than 11 metres from the boundary it faces.	The extension has no above ground level wall mounted windows within 11 metres of any boundary. The roof windows to no face any boundary, being orientated skyward.
6. (c)	Where the house is detached and the floor area of the extension above ground level exceeds 12 square metres, any window proposed at above ground level shall not be less than 11 metres from the boundary it faces.	n/a
7.	The roof of any extension shall not be used as a balcony or roof garden.	The roof of the extension cannot be used as an open space due to its slope.

The application indicates that the shed to the rear of the property is exempt in accordance with Class 3 of Schedule 2, Article 6 which is:

The construction, erection or placing within the curtilage of a house of any tent, awning, shade or other object, greenhouse, garage, store, shed or other similar structure.

The following table will check whether the shed as constructed accords with the conditions and limitations associated with this class of development:

1.	No such structure shall be constructed, erected or placed forward of the front wall of a house.	The shed is to the rear of the house.
2.	The total area of such structures constructed, erected or placed within the curtilage of a house shall not, taken together with any other such structures previously constructed, erected or placed within the said curtilage, exceed 25 square metres.	The shed has a stated floor area of 20.7m ² .
3.	The construction, erection or placing within the curtilage of a house of any such structure shall not reduce the amount of private open space reserved exclusively for the use of the occupants of the house to the rear or to the side of the house to less than 25 square metres.	The remaining open space to the rear of the dwelling is stated to be 76m ² .
4.	The external finishes of any garage or other structure constructed, erected or placed to the side of a house, and the roof covering where any such structure has a tiled or slated roof, shall conform with those of the house.	n/a
5.	The height of any such structure shall not exceed, in the case of a building with a tiled or slated pitched roof, 4 metres or, in any other case, 3 metres.	The height of the structure is stated to be 3.4m and has a pitched roof.
6.	The structure shall not be used for human habitation or for the keeping of pigs, poultry, pigeons, ponies or horses, or for any other purpose other than a purpose incidental to the enjoyment of the house as such.	The further information states that the structure accords with this limitation.

Article 9 (1) further sets out a number of limitations to the exemptions provided for by Article 6. It is considered that the extension and shed do not contravene these limitations.

4. ENVIRONMENTAL ASSESSMENT

4.1 Screening for Environmental Impact Assessment

Having regard to the contents of Article 103 (as amended by Article 14 of the Planning and Development (Amendment) (No 3) Regulations 2011) and Schedule 7 of the Planning and Development Regulations 2001 (as amended) it is considered that the proposed development by reason of its nature, scale and location would not be likely to have significant effects on the environment. Accordingly it is considered that an environmental impact statement is not required to be submitted.

4.2 Screening for Appropriate Assessment

Section 177U (9) of the Act requires planning authorities to screen applications for a section 5 declaration for appropriate assessment. The provisions of the *Habitats Directive*, the *Appropriate Assessment Guidelines for Planning Authorities 2009* (revised 2010) and the Act are noted. The relevant European sites are the Cork Harbour SPA (site code 004030) and the Great Island Channel cSAC (site code 001058). Having regard to the location of the proposed development site relative to these European sites and related watercourses and to the nature and scale of the proposed development it is considered that the proposed development would not affect the integrity of the European sites referred to above. Accordingly it is considered that appropriate assessment is not required.

5. RECOMMENDATION

In view of the above and having regard to —

- Sections 2 and 3 of the *Planning and Development Act 2000* (as amended), and
- Articles 6 and 9 of the *Planning and Development Regulations 2001* (as amended),

It is considered that *the construction of the extension and the shed constructed to the rear of 42 Sidney Park, Wellington Road, Cork Is Development and Is Exempted Development.*

Martina Foley
Executive Planner

Agreed MW
04/10/19

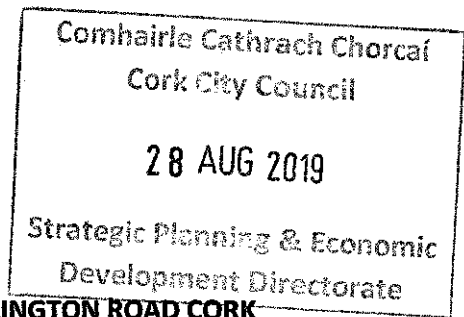

SECTION 5 DECLARATION REQUEST 42 SIDNEY PARK WELLINGTON ROAD CORK

A Chara,

The above and yours of the 31st July inst refer.

The initial application submitted was probably short on clarification to facilitate an early response. Please find further clarification submitted in support of the requested section 5 exemption declaration sought.

- Att A : Original site lease map of 19th June 1941 described in Imperial measurements.
- Att B : OSI map of site scale of 1:1000 which is the urban standard produced by OSI.
- Att C : Blow up of Att B featuring gross dimensions of rear Garden space including Garden shed area of the rear extension and side of house.
- Att D : Site map previously submitted with retention application for south facing conservatory scale 1:200 ref 02/26138.
- Att E : Garden Shed Floor Plan.
- Att F :Garden Shed Elevation.
- Att G : Garden Shed Section.
- Att H : Scale Plan of extension 1: 100 dated June 2008.

The Original lease confirms the property as a pre 1963 construction and as a consequence the first recorded depiction of the site complete with buildings thereon is the OSI map (Att B) dating from the 1973 survey revised in 2001. The main residence and Garden shed are clearly depicted on the map. The site dimensions accord with those depicted as imperial measurements in the original lease site map when converted.

The 2002 site map (Att D) submitted as part of the previous retention permission granted in 2002 also accords with the dimensions recorded on the OSI map and likewise records the existence of the Garden Shed location and dimensions.

The extension dimensions are mutually confirmed by Att D of 2002 and Att H of 2008 and measure the extension area as 4.3m wide by 3 m deep. This equates to a floor area of 13 m squared approx.

The Garden Shed Floor Plan(Att E) and OSI map Blow up (Att C) record shed footprint gross dimensions of 6.9m by 3 m giving a total of 20.7m squared approx.

The Garden Shed elevation (Att F) depicts a Ridge height of 3.4m.

The Garden Shed Section (Att G) measures the masonry sill height as 2.4m.

With respect to the Class 1 structures extending the house proper, the floor area of the front previously approved extension is less than 14m squared while the rear extension is 13m squared giving a total of 27m squared.

With respect to the Class 3 structure the total area is 20.7m squared.

The Gross dimensions of the rear garden and Shed and rear extension feature in Att C.

The remaining area of private space to the rear of the property remains at 76m squared approx.

The remaining area of private space to the side of the property is 34m squared approx.

All measurements have been taken on site and inspection and verification are welcomed.

As these developments appear to be within the exempted development limits for Class 1(40 m squared) and Class 3 developments (25 m squared and 4 m ridge height) and as the remaining private spaces exclusively for the use of the occupants to the rear and side of the property remains at 110m squared approx, We would be grateful if a section 5 declaration regarding exempted development could issue at your earliest convenience.

We confirm that the shed is not used for human habitation or for the housing of any livestock or animals.

We await your reply

Mise le Meas

Terence and Jean Canton

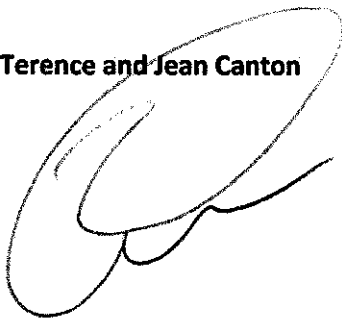
A handwritten signature in black ink, appearing to be a stylized 'T' and 'J' combined, located below the printed name 'Terence and Jean Canton'.

ATT A

X69119

John F. O'Mahony

DEWIS O'CONNELL AND TRUSTEES

IT

John F. O'Mahony

LEASE

32 2/3

1/4

W.F. O'CONNOR HARVEY & CO.

Solicitors

55 South Main
Providence

MAP REFERRED TO

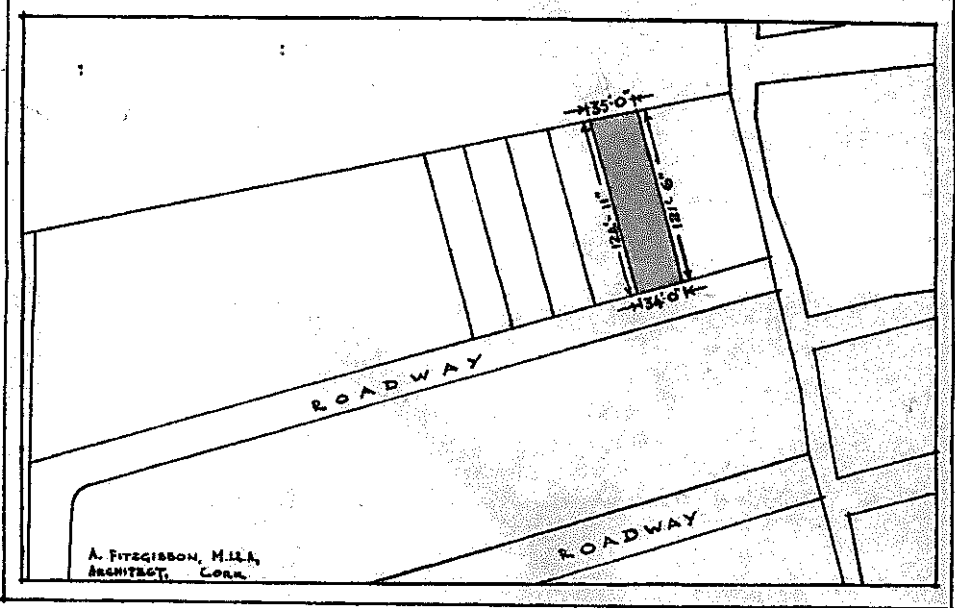

Surveyed 1973 - 2001
 Revised 2001 - 1973
 Levelled 1973 - 1983

ATT B

Urban PLACE Map



169173 72545

DESCRIPTION

1:1000

- 6382-10 6383-06
- 6382-05 6383-01

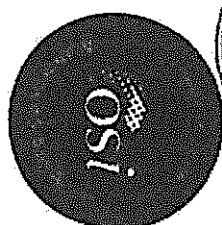

Produced by Central Survey Services, Don C. ...
 OSi
 © Ordnance Survey Limited, 2002

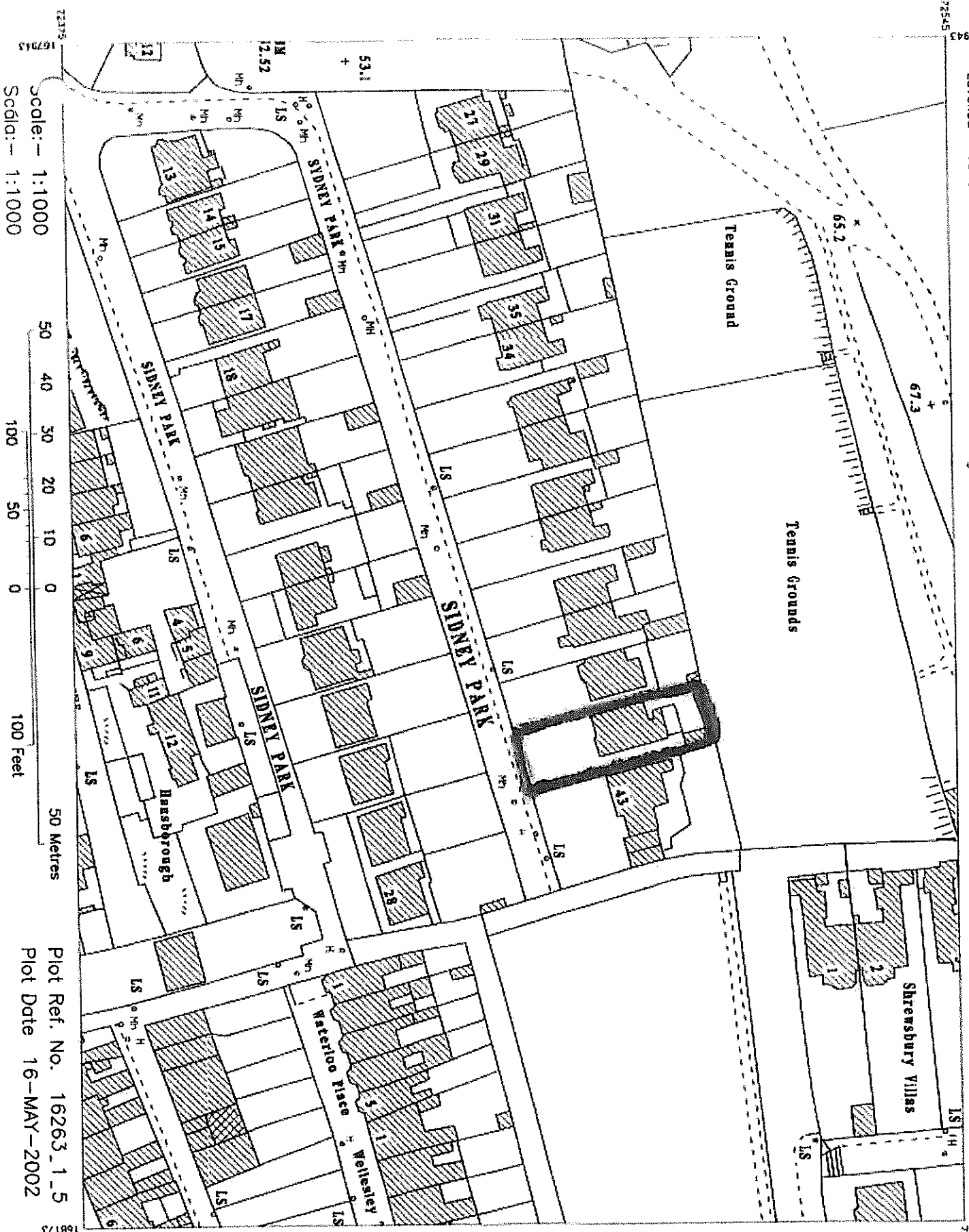

Scale: 1:1000
 Scale: 1:1000

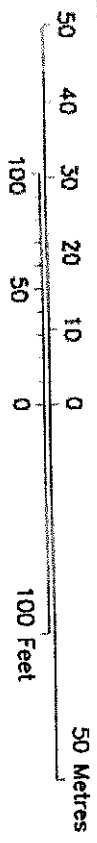

Plot Ref. No. 16263_1_5
 Plot Date 16-MAY-2002

ATT C

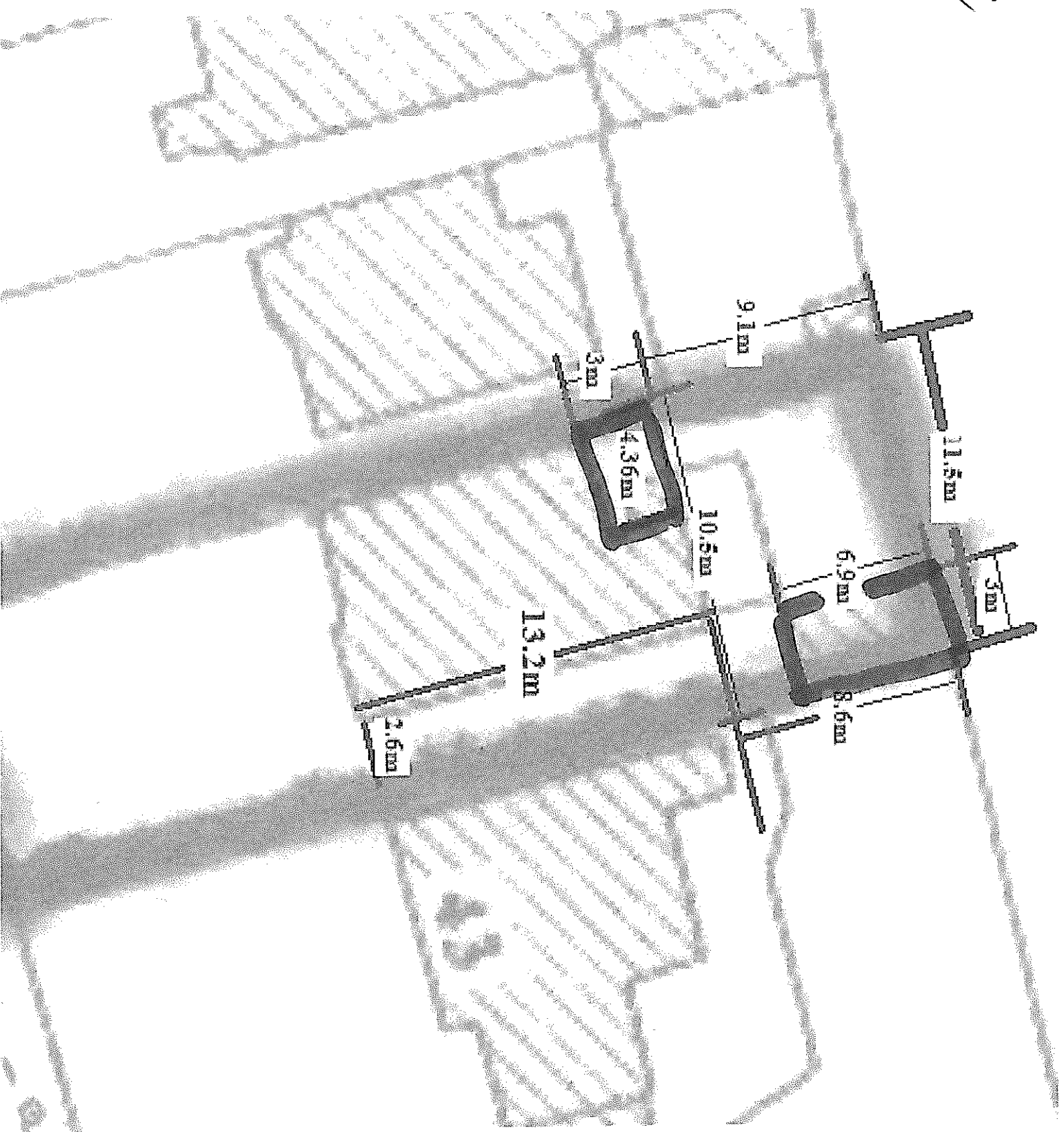

Garden Shed Floor Plan
All Measured in Metres

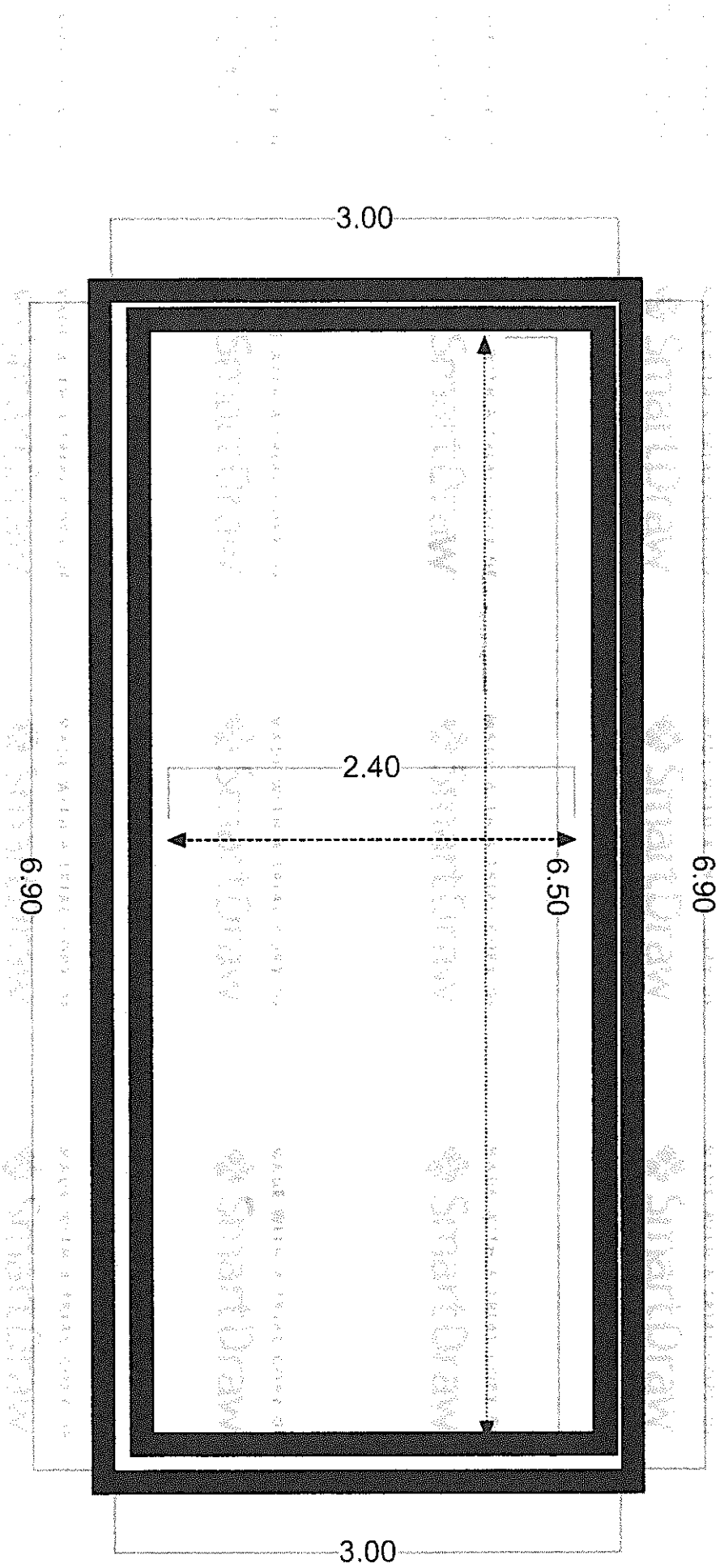

Att F

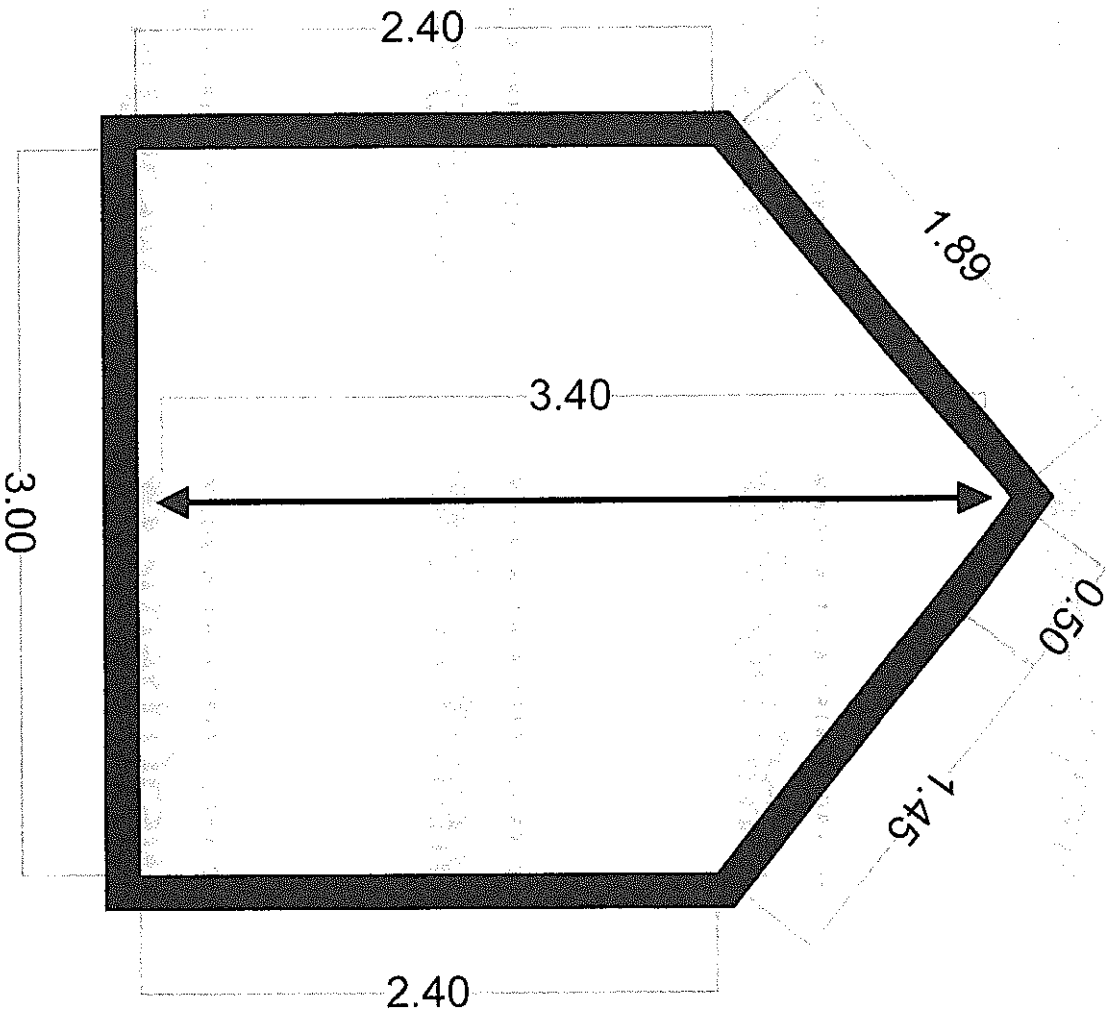

Garden Shed Elevation
all measurements in metres

Att G

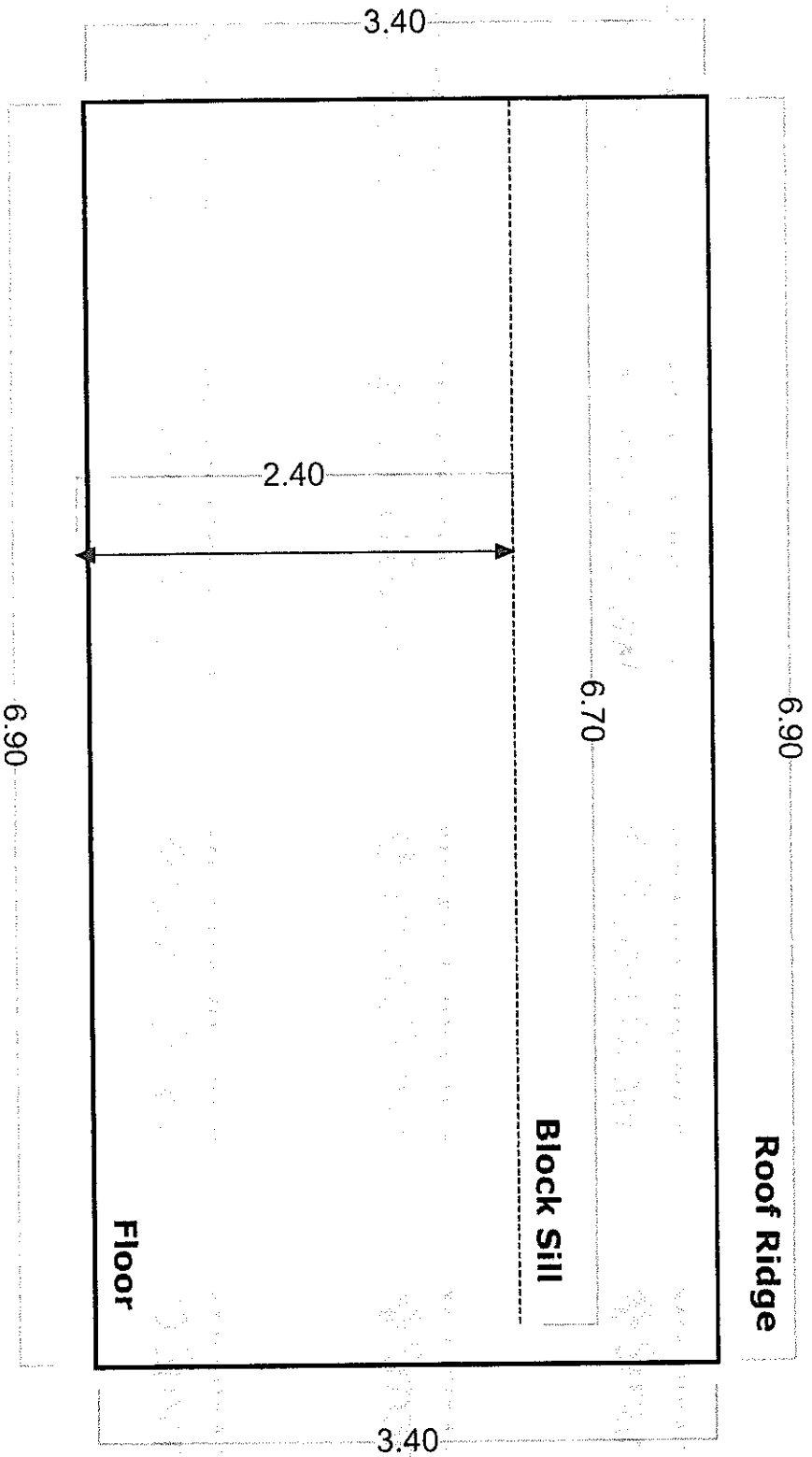

Garden Shed Section
All Measurements in Metres

ATT D

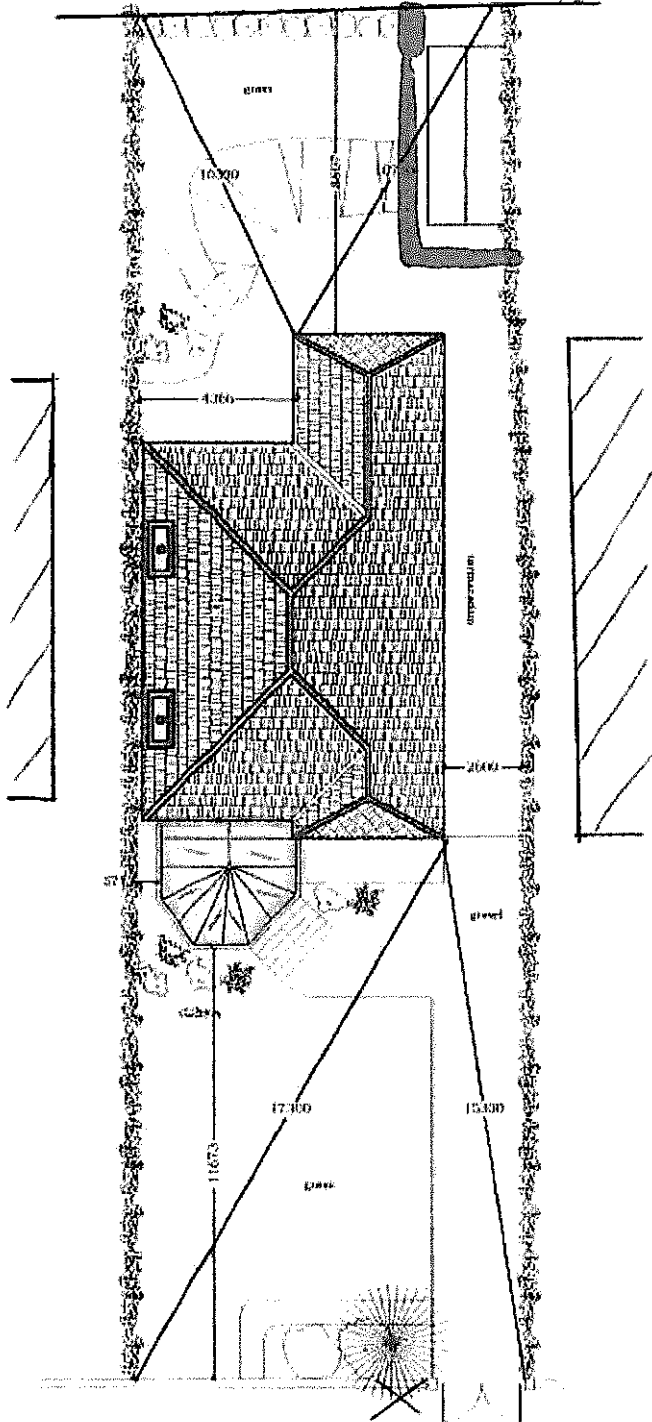

SITE NOTICE

BALLYHOOLY NEW ROAD

NOTE

THESE DRAWINGS ARE FOR PLANNING APPROVAL AND/OR PERMISSION ONLY

ALL REFERENCES TO IRISH/BRITISH STANDARDS, CODES OF PRACTICE ETC. ARE TO BE TO THE LATEST UP-TO-DATE EDITIONS OF THE SAME

ALL CONSTRUCTION WORK TO COMPLY WITH THE LATEST EDITION OF THE NEW BUILDING REGULATIONS

TAKE FIGURED DIMENSIONS IN PREFERENCE TO SCALED

CHECK ALL DIMENSIONS ON SITE BEFORE COMMENCING WORKS



WISEMANS DESIGNS

ARCHITECTURAL CONSULTANCY

1 Lincoln Place, Galtan Hill, Cork, Ireland.

Tel/Fax: 00 353(0)21 4553644

wisemandesigns@eircom.net

<p>PLAN TITLE</p> <p>PLANNING RETENTION for 'NORVILLE' SYDNEY PARK CORK CITY</p>
--

<p>DATE</p> <p>SITE PLAN</p>

<p>DATE</p> <p>13 MAY 02</p>	<p>DESIGNER</p> <p>A.W.</p>	<p>PROJECT</p> <p>Norv10-02-01/01</p>	<p>SCALE</p> <p>1:200</p>
------------------------------	-----------------------------	---------------------------------------	---------------------------

ART H1

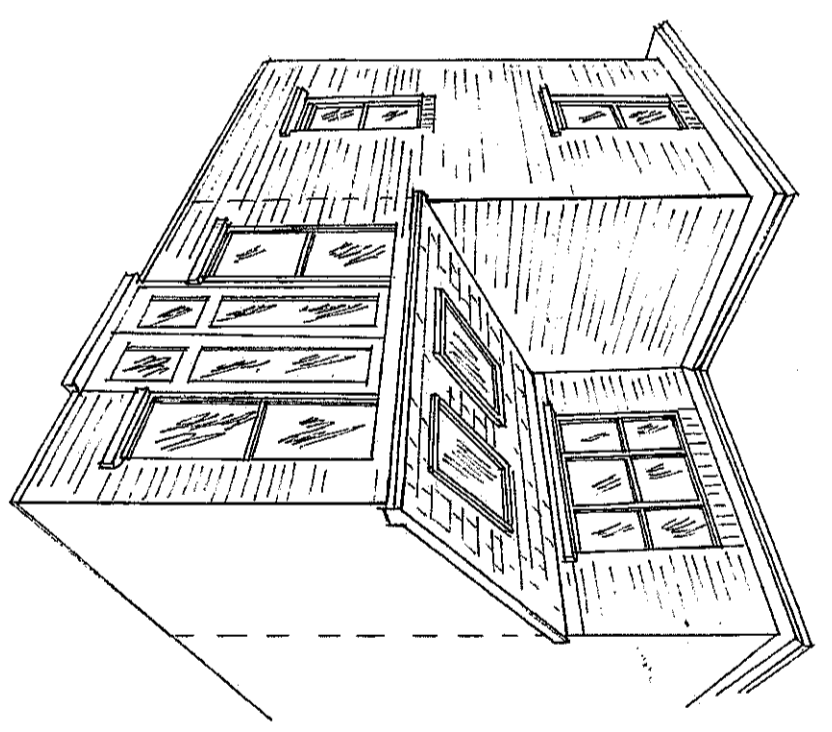
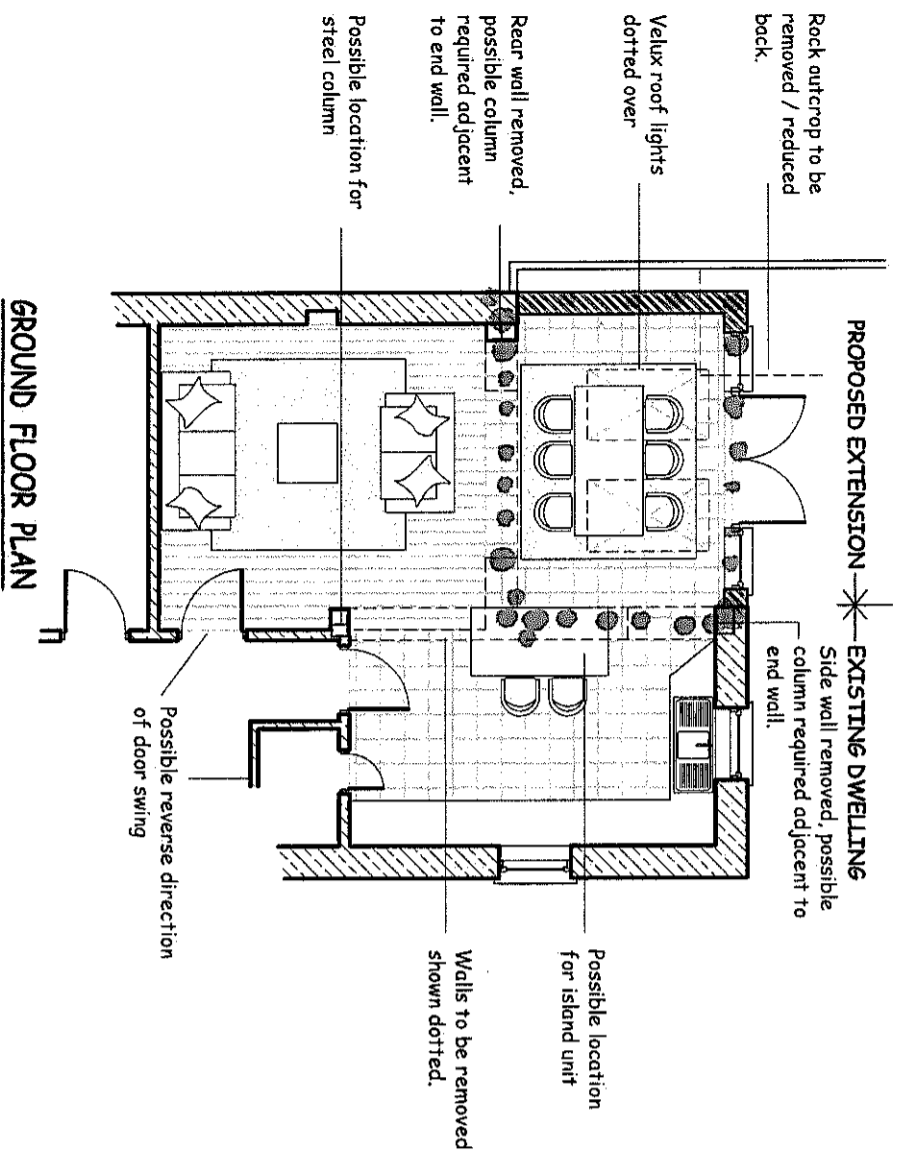
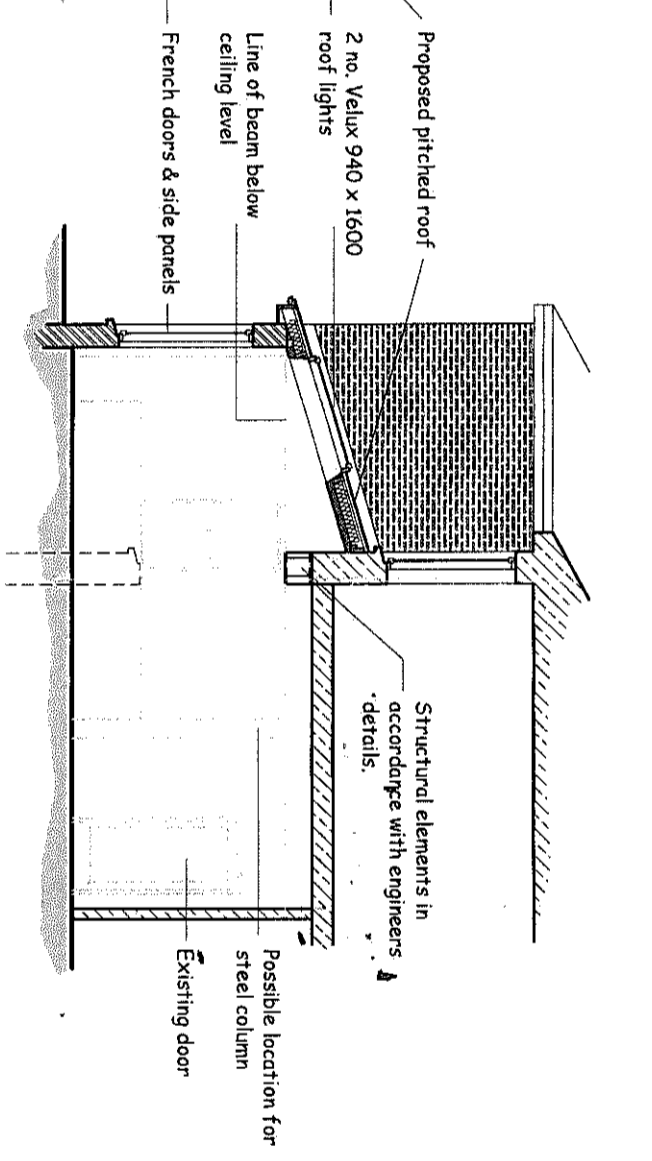
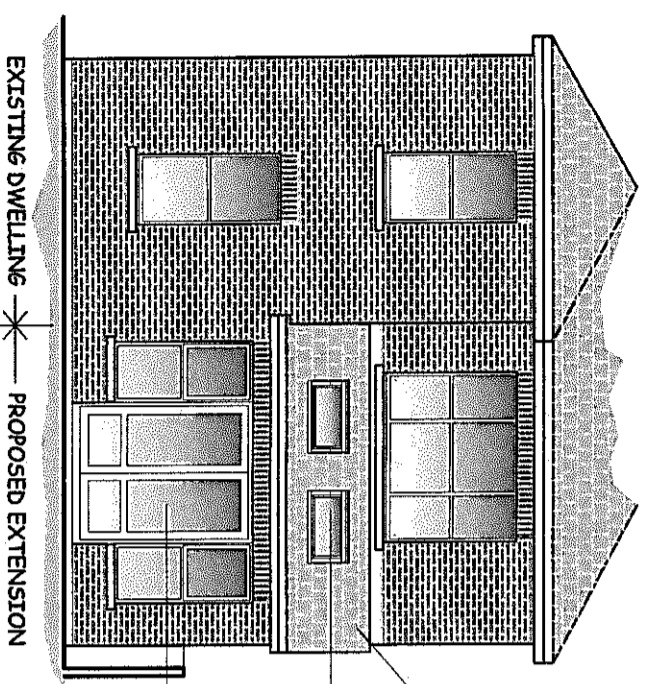

ALL STRUCTURAL STEEL ELEMENTS TO BE DESIGNED BY A STRUCTURAL ENGINEER, ALL DIMENSIONS TO BE CHECKED ON SITE.

OPTION 1

PRELIMINARY ISSUE
6-6-2008

Revision:

Client
Jean & Terry Canton

Project
Proposed Extension To Dwelling
Norville Sidney Park Wellington Road Cork

Drawing Title
Preliminary Drawing

Scale: A3
1:100

Date
June 2008

Drawn
JOC

Drawing No.
2008-28

MDD architects

ARCHITECTURAL DESIGN PLANNING CONSULTANTS PROJECT MANAGEMENT

43 Bank Place Malpas Co. Cork
Tel: 022 33520
Fax: 022 55448
Web: www.mdd-architects.com

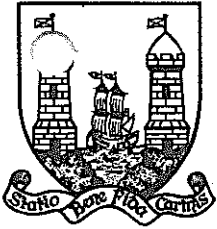

Comhairle Cathrach Chorcaí Cork City Council

Halla na Cathrach, Corcaigh - City Hall, Cork - T12 T997

Terence and Jean Canton,
Norville,
42 Sidney Park,
Wellington Road,
Cork

31st July, 2019

**RE: Section 5 Declaration – 42 Sidney Park,
Wellington Road, Cork**

Dear Sir/Madam,

With reference to your request for a section 5 Declaration at the above named property, I wish to advise as follows:

it is recommended that Further Information be sought in accordance with Section 5(2)(b) of the *Planning and Development Act 2000*. The information to be sought is as follows:

1. A site plan to scale with principle dimensions, including distance to boundary and the width and length of the rear garden, showing the location of the extension and shed that are the subject of this Section 5 Referral.
2. Revised plans showing the extension element to include principle dimensions.
3. Floor plan, elevation and section of the shed.
4. Confirmation that the shed is not used for human habitation.

Yours Faithfully,

Eileen Kiely
Clerical Officer
Development Management Section
Community, Culture and Placemaking Directorate
Cork City Council



We are Cork.

PLANNER'S REPORT Ref. R523 /19		Cork City Council Development Management Strategic Planning and Economic Development
Application type	Section 5 Declaration	
Description	<i>Whether the construction of a rear extension at the below address is development and if so is it exempted development, and Whether the construction of a shed to the rear of the below address is development and if so if it is exempted development.</i>	
Location	42 Sidney Park, Wellington Road, Cork	
Applicant	Terrance & Jean Canton	
Date	23/07/2019	
Recommendation	<i>Further Information be Requested</i>	

In this report 'the Act' means the Planning and Development Act 2000 (as amended) and 'the Regulations' means the Planning and Development Regulations 2001 (as amended), unless otherwise indicated.

1. Requirements for a Section 5 Declaration

Section 5(1) of the Planning and Development Act 2000 as amended states,

5.—(1) If any question arises as to what, in any particular case, is or is not development or is or is not exempted development within the meaning of this Act, any person may, on payment of the prescribed fee, request in writing from the relevant planning authority a declaration on that question, and that person shall provide to the planning authority any information necessary to enable the authority to make its decision on the matter.

The requirements for making a section 5 declaration are set out in the Act.

2. The Question before the Planning Authority

In framing the question to the planning authority, the applicant states in Q2 of the application form:

Is the construction of the rear extension at the above address development and if so is it exempted development in association with is the shed constructed to the rear of the above address development and if so is it exempted development?

3. Site Description

The property in question is a two storey detached dwelling with a conservatory on the south face, the front of the dwelling. The extension and shed, which are the subject of this Section 5 Application, are extant and located to the north of the dwelling (rear).

4. Planning History

There is one recent planning permission associated with the site summarised as follows:

App Ref	Description	Condition(s)
02/26138	Retention of Conservatory	One condition – development to be retained in accordance with submitted plans.

5. Legislative Provisions

5.1 The Act

Section 2(1),

“works” includes any act or operation of construction, excavation, demolition, extension, alteration, repair or renewal and, in relation to a protected structure or proposed protected structure, includes any act or operation involving the application or removal of plaster, paint, wallpaper, tiles or other material to or from the surfaces of the interior or exterior of a structure.

Section 3(1),

In this Act, “development” means, except where the context otherwise requires, the carrying out of any works on, in, over or under land or ‘the making of any material change in the use of any structures or other land’

Section 4(1)(h),

The following shall be exempted developments for the purposes of this Act-development consisting of the carrying out of works for the maintenance, improvement or other alteration of any structure, being works which affect only the interior of the structure or which do not materially affect the external appearance of the structure so as to render the appearance inconsistent with the character of the structure or of neighbouring structures;

Section 4(2),

Section 4(2) provides that the Minister may, by regulations, provide for any class of development to be exempted development. The principal regulations made under this provision are the Planning and Development Regulations 2001-2013.

Section 5(1),

(See section 1 of this report)

Section 177U (9) (screening for appropriate assessment)

In deciding upon a declaration or a referral under section 5 of this Act a planning authority or the Board, as the case may be, shall where appropriate, conduct a screening for appropriate assessment in accordance with the provisions of this section.

5.2 The Regulations

Article 6 (1)

Subject to article 9, development of a class specified in column 1 of Part 1 of Schedule 2 shall be exempted development for the purposes of the Act, provided that such development complies with the conditions and limitations specified in column 2 of the said Part 1 opposite the mention of that class in the said column 1.

SCHEDULE 2, ARTICLE 6, PART 1, Exempted Development — General

Column 1 Description of Development	Column 2 Conditions and Limitations
<i>Development within the curtilage of a house</i> CLASS 1 The extension of a house, by the construction or erection of an extension (including a conservatory) to the rear of the house or by the conversion for use as part of the house of any garage, store, shed or other similar structure attached to the rear or to the side of the house.	1. (a) Where the house has not been extended previously, the floor area of any such extension shall not exceed 40 square metres. (b) Subject to paragraph (a), where the house is terraced or semi-detached, the floor area of any extension above ground level shall not exceed 12 square metres. (c) Subject to paragraph (a), where the house is detached, the floor area of any extension above ground level shall not exceed 20 square metres.
	2. (a) Where the house has been extended previously, the floor area of any such extension, taken together with the floor

	<p>area of any previous extension or extensions constructed or erected after 1 October 1964, including those for which planning permission has been obtained, shall not exceed 40 square metres.</p> <p>(b) Subject to paragraph (a), where the house is terraced or semi-detached and has been extended previously, the floor area of any extension above ground level taken together with the floor area of any previous extension or extensions above ground level constructed or erected after 1 October 1964, including those for which planning permission has been obtained, shall not exceed 12 square metres.</p> <p>(c) Subject to paragraph (a), where the house is detached and has been extended previously, the floor area of any extension above ground level, taken together with the floor area of any previous extension or extensions above ground level constructed or erected after 1 October 1964, including those for which planning permission has been obtained, shall not exceed 20 square metres.</p>
	<p>3. Any above ground floor extension shall be a distance of not less than 2 metres from any party boundary.</p>
	<p>4. (a) Where the rear wall of the house does not include a gable, the height of the walls of any such extension shall not exceed the height of the rear wall of the house.</p> <p>(b) Where the rear wall of the house includes a gable, the height of the walls of any such extension shall not exceed the height of the side walls of the house.</p> <p>(c) The height of the highest part of the roof of any such extension shall not exceed, in the case of a flat roofed extension, the height of the eaves or parapet, as may be appropriate, or, in any other case, shall not exceed the height of the highest part of the roof of the dwelling.</p>
	<p>5. The construction or erection of any such extension to the rear of the house shall not reduce the area of private open space, reserved exclusively for the use of the occupants of the house, to the rear of the house to less than 25 square metres.</p>
	<p>6. (a) Any window proposed at ground level in any such extension shall not be less than 1 metre from the boundary it faces.</p> <p>(b) Any window proposed above ground level in any such extension shall not be less than 11 metres from the boundary it faces.</p> <p>(c) Where the house is detached and the floor area of the extension above ground level exceeds 12 square metres, any window proposed at above ground level shall not be less than 11 metres from the boundary it faces.</p>
	<p>7. The roof of any extension shall not be used as a balcony or roof garden.</p>
<p>CLASS 3 The construction, erection or placing within the curtilage of a house of any tent, awning, shade or other object, greenhouse, garage, store, shed or other similar structure.</p>	<p>1. No such structure shall be constructed, erected or placed forward of the front wall of a house.</p> <p>2. The total area of such structures constructed, erected or placed within the curtilage of a house shall not, taken together with any other such structures previously constructed, erected or placed within the said curtilage, exceed 25 square metres.</p> <p>3. The construction, erection or placing within the curtilage of a house of any such structure shall not reduce the amount of private open space reserved exclusively for the use of the occupants of the house to the rear or to the side of the house to less than 25 square metres.</p> <p>4. The external finishes of any garage or other structure constructed, erected or placed to the side of a house, and</p>

	<p>the roof covering where any such structure has a tiled or slated roof, shall conform with those of the house.</p> <p>5. The height of any such structure shall not exceed, in the case of a building with a tiled or slated pitched roof, 4 metres or, in any other case, 3 metres.</p> <p>6. The structure shall not be used for human habitation or for the keeping of pigs, poultry, pigeons, ponies or horses, or for any other purpose other than a purpose incidental to the enjoyment of the house as such.</p>
--	---

Article 9 (1)

Development to which article 6 relates shall not be exempted development for the purposes of the Act

–

- (a) (i) *if the carrying out of such development would... contravene a condition attached to a permission under the Act or be inconsistent with any use specified in a permission under the Act,*
- (a) (viii) *consist of or comprise the extension, alteration, repair or renewal of an unauthorised structure or a structure the use of which is an unauthorised use,*

6. ASSESSMENT**5.1 Development**

The first issue for consideration is whether or not the matter at hand is ‘development’.

‘Development’ as defined in the Act (3)(1) comprises two possible chief components: ‘the carrying out of any works on, in, over or under land’, or ‘the making of any material change in the use of any structures or other land’. In order to ascertain whether or not the subject use is considered to be development as so defined, consideration must first be given to whether any works on, in, over or under land have or will be carried out, and secondly to whether any material change in the use of any structures or other land have or will take place.

‘Works’ is defined in section 2(1) of the Act as ‘the carrying out of any works on, in, over, or under land’ including ‘any act or operation of construction, excavation, demolition, extension, alteration, repair or renewal, and in relation to a protected structure or proposed protected structure, includes any act or operation involving the application or removal of plaster, paint wallpaper, tiles or other material to or from the surfaces of the interior or exterior of a structure.’

I consider that the construction of both the extension and the shed constitute the carrying out of works and as such constitute development.

5.2 Exempted development

The next issue for consideration is whether or not the matter at hand is exempted development. Class 1 developments, as set out in Schedule 2 of the *Planning and Development Regulations 2001* (as amended), include extensions to dwellings. Class 3 as set out in the same schedule includes sheds. The query here is whether the subject development meets the conditions and limitations as set out in Column 2.

The applicant has provided a plan with ground plan, elevations and section showing the extension. The plans are not dimensioned and no site plan has been provided. While the shed structure does appear to be shown in a site plan provided that formed part of the 2002 application (02/26138) no dimensions are shown. There are no plans showing details of the shed.

It is not possible therefore to assess whether nor not the extension and/or shed comply with the conditions and limitations set out regarding Class 1 and Class 3 developments.

7. ENVIRONMENTAL ASSESSMENT

7.1 *Screening for Environmental Impact Assessment*

Having regard to the contents of Article 103 (as amended by Article 14 of the Planning and Development (Amendment) (No 3) Regulations 2011) and Schedule 7 of the Planning and Development Regulations 2001 (as amended) it is considered that the proposed development by reason of its nature, scale and location would not be likely to have significant effects on the environment. Accordingly it is considered that an environmental impact statement is not required to be submitted.

7.2 *Screening for Appropriate Assessment*

Section 177U (9) of the Act requires planning authorities to screen applications for a section 5 declaration for appropriate assessment. The provisions of the *Habitats Directive*, the *Appropriate Assessment Guidelines for Planning Authorities 2009* (revised 2010) and the Act are noted. The relevant European sites are the Cork Harbour SPA (site code 004030) and the Great Island Channel cSAC (site code 001058). Having regard to the location of the proposed development site relative to these European sites and related watercourses and to the nature and scale of the proposed development it is considered that the proposed development would not affect the integrity of the European sites referred to above. Accordingly it is considered that appropriate assessment is not required.

8. RECOMMENDATION

In view of the above it is recommended that Further Information be sought in accordance with Section 5(2)(b) of the *Planning and Development Act 2000*. The information to be sought is as follows:

1. A site plan to scale with principle dimensions, including distance to boundary and the width and length of the rear garden, showing the location of the extension and shed that are the subject of this Section 5 Referral.
2. Revised plans showing the extension element to include principle dimensions.
3. Floor plan, elevation and section of the shed.
4. Confirmation that the shed is not used for human habitation.



Martina Foley
Executive Planner

**COMHAIRLE CATHRACH CHORCAÍ
CORK CITY COUNCIL**

Strategic Planning & Economic Development Directorate,
Cork City Council, City Hall, Anglesea Street, Cork.

**Comhairle Cathrach Chorcaí
Cork City Council**

08 JUL 2019

R-Phost/E-Mail planning@corkcity.ie
Strategic Planning & Economic
Development Directorate
Lionel Webber

SECTION 5 DECLARATION APPLICATION FORM
under Section 5 of the Planning & Development Acts 2000 (as amended)

1. POSTAL ADDRESS OF LAND OR STRUCTURE FOR WHICH DECLARATION IS SOUGHT

42 Sidney Park, Wellington Road Cork City,
T23 EEV6

2. QUESTION/ DECLARATION DETAILS

PLEASE STATE THE SPECIFIC QUESTION FOR WHICH A DECLARATION IS SOUGHT:
Sample Question: Is the construction of a shed at No 1 Wall St, Cork development and if so, is it exempted development?

Note: only works listed and described under this section will be assessed under the section 5 declaration.

IS THE CONSTRUCTION OF THE REAR EXTENSION AT THE ABOVE ADDRESS DEVELOPMENT AND IF SO IS IT EXEMPTED DEVELOPMENT IN ASSOCIATION WITH IS THE SHED CONSTRUCTED TO THE REAR OF THE ABOVE ADDRESS DEVELOPMENT AND IF SO IS IT EXEMPTED DEVELOPMENT?

ADDITIONAL DETAILS REGARDING QUESTION/ WORKS/ DEVELOPMENT:
(Use additional sheets if required).

3. APPLICATION DETAILS

Answer the following if applicable. Note: Floor areas are measured from the inside of the external walls and should be indicated in square meters (sq. M)

(a) Floor area of existing/proposed structure/s	12.9m ² + 17.82m ² = 30.72m ² EXTENSION SHED
(b) If a domestic extension, have any previous extensions/structures been erected at this location after 1 st October, 1964, (including those for which planning permission has been obtained)?	Yes <input checked="" type="checkbox"/> No <input type="checkbox"/> If yes, please provide floor areas. (sq m) 11.27m ² RETENTION PERMISSION 4th 2002
(c) If concerning a change of use of land and / or building(s), please state the following:	
Existing/ previous use (please circle)	Proposed/existing use (please circle)
NA	NA

4. APPLICANT/ CONTACT DETAILS

Name of applicant (principal, not agent):	TERENCE E JEAS CANSOW		
Applicants Address	NORVILLE, 42 SIDNEY PARK WELLINGTON ROAD COCK CITY		
Person/Agent acting on behalf of the Applicant (if any):	Name:		
	Address:		
	Telephone:		
	Fax:		
	E-mail address:		
Should all correspondence be sent to the above address? <small>(Please note that if the answer is 'No', all correspondence will be sent to the Applicant's address)</small>	Yes <input checked="" type="checkbox"/>	No <input type="checkbox"/>	

5. LEGAL INTEREST

Please tick appropriate box to show applicant's legal interest in the land or structure	A. Owner <input checked="" type="checkbox"/>	B. Other <input type="checkbox"/>
Where legal interest is 'Other', please state your interest in the land/structure in question		
If you are not the legal owner, please state the name and address of the owner if available	NA	

MRS O'CONNELL AND OTHERS

To

John F. O'Mahony

LEASE

22-76

F O'CONNOR HARNEY & Co.,
Solicitors,
55 SOUTH MAIN
COURT

MAP REFERRED TO

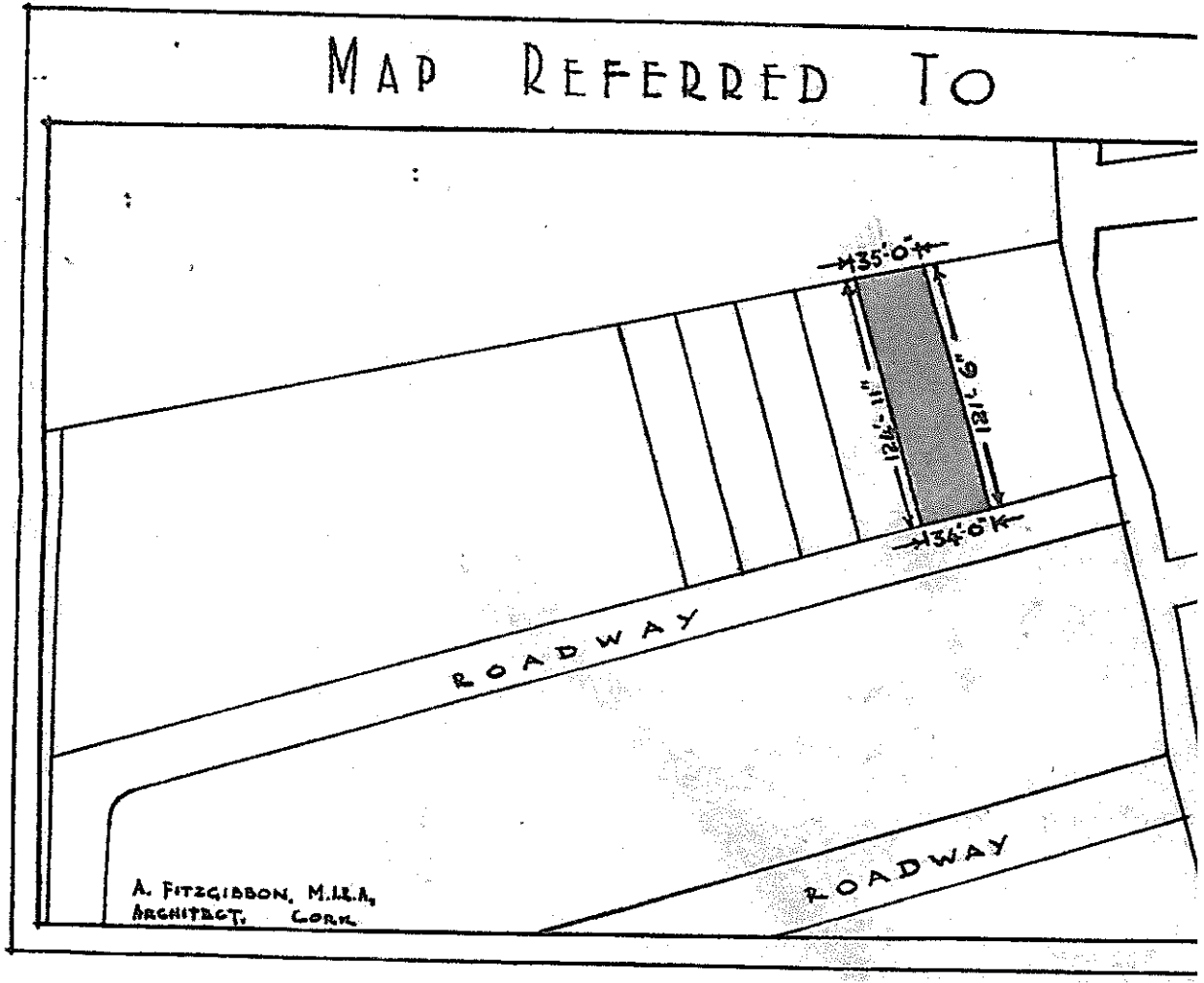

A. FITZGIBSON, M.I.A.,
ARCHITECT, CORP.

ROADWAY

ROADWAY

PLANNING RETENTION
AT
No. 42 SIDNEY PARK
WELLINGTON ROAD
CORK

CLIENT: PATRICK MURPHY
DATE : MAY 2002



WISEMANDESIGNS
ARCHITECTURAL CONSULTANCY

▼ Open Menu

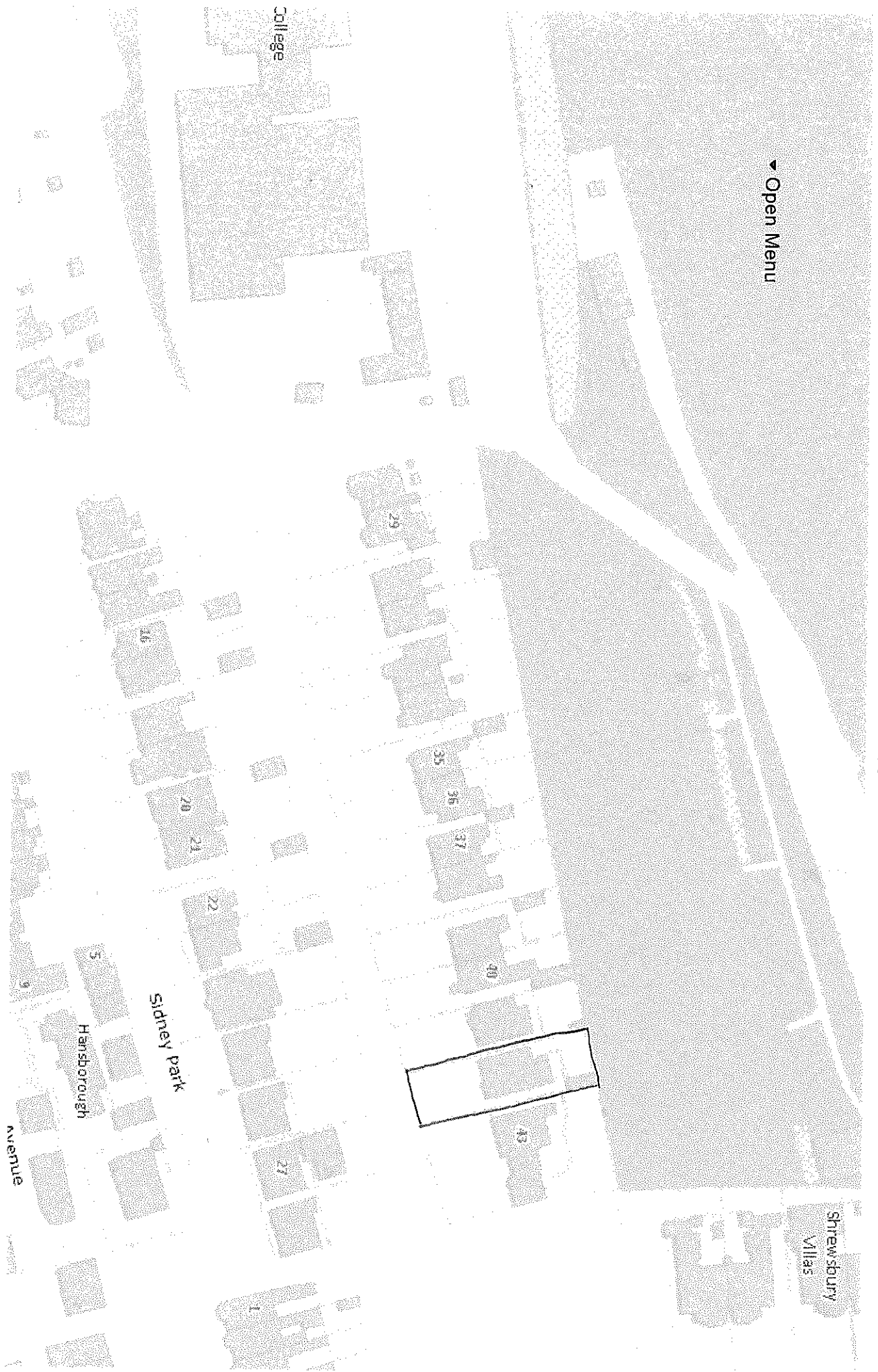

Surveyed 1973
 Revised 2001 - 2001
 Levelled 1973 - 1983

Urban PLACE Map



DISCONTINUED

2000 SCALE

- 1:1000
- 6382-10
- 6382-05
- 6383-06
- 6383-01

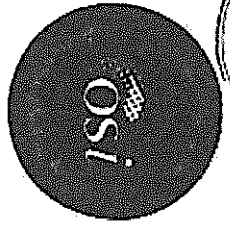

Produced by Ordnance Survey, Dublin, Ireland. OSi is a registered trademark of Ordnance Survey. All rights reserved. No part of this publication may be reproduced, stored in a retrieval system, or transmitted in any form or by any means, without the prior written permission of the copyright owner.

© Ordnance Survey, Dublin, 2002

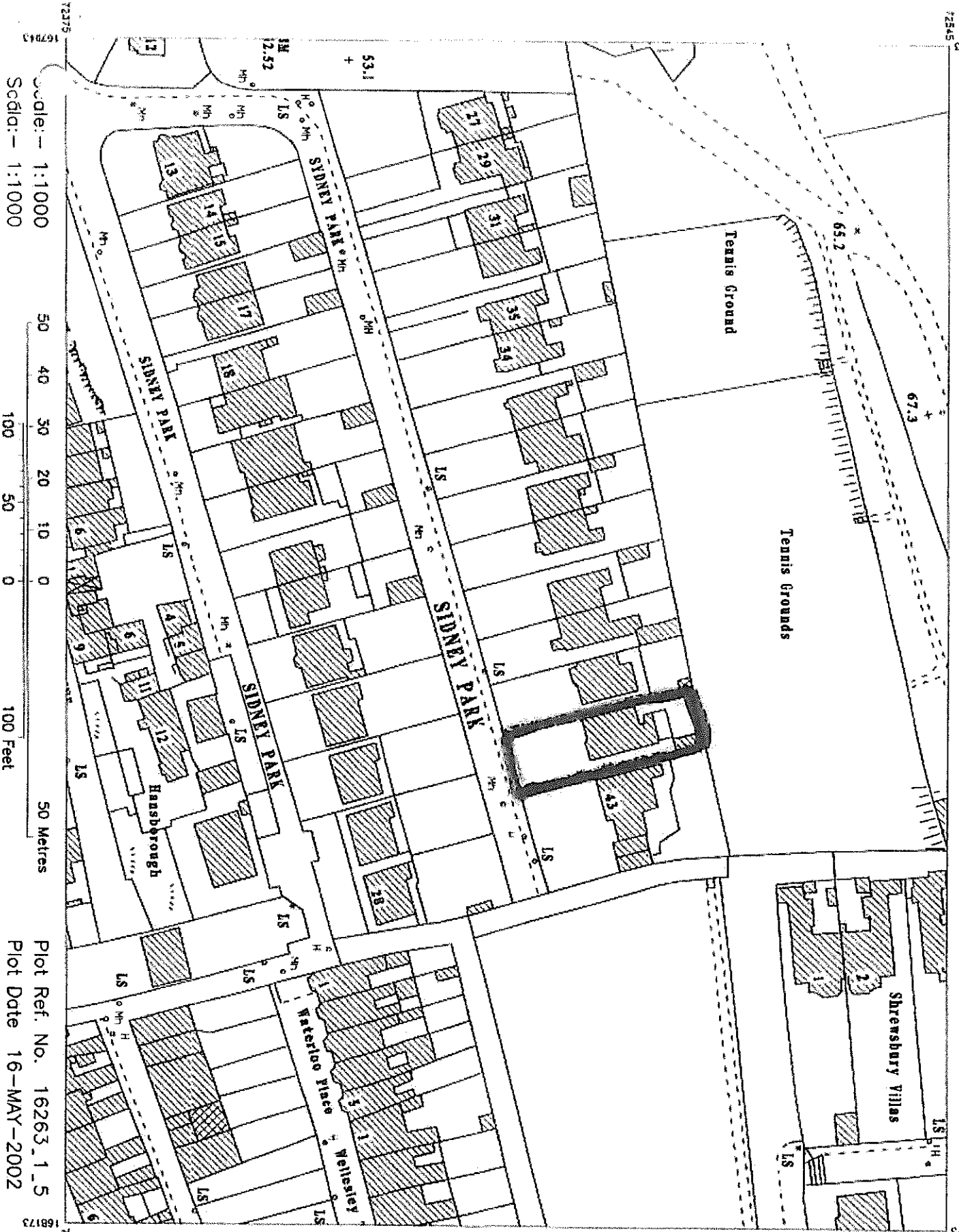

Scale: 1:1000
 Scale: 1:1000

50 Metres
 100 Feet

Plot Ref. No. 16263_1_5
 Plot Date 16-MAY-2002

NOTE

THESE DRAWINGS ARE FOR PLANNING APPROVAL AND/OR PERMISSION ONLY

ALL REFERENCES TO IRISH/BRITISH STANDARDS, CODES OF PRACTICE ETC. ARE TO BE TO THE LATEST UP-TO-DATE EDITIONS OF THE SAME

ALL CONSTRUCTION WORK TO COMPLY WITH THE LATEST EDITION OF THE NEW BUILDING REGULATIONS

TAKE FIGURED DIMENSIONS IN PREFERENCE TO SCALED

CHECK ALL DIMENSIONS ON SITE BEFORE COMMENCING WORKS

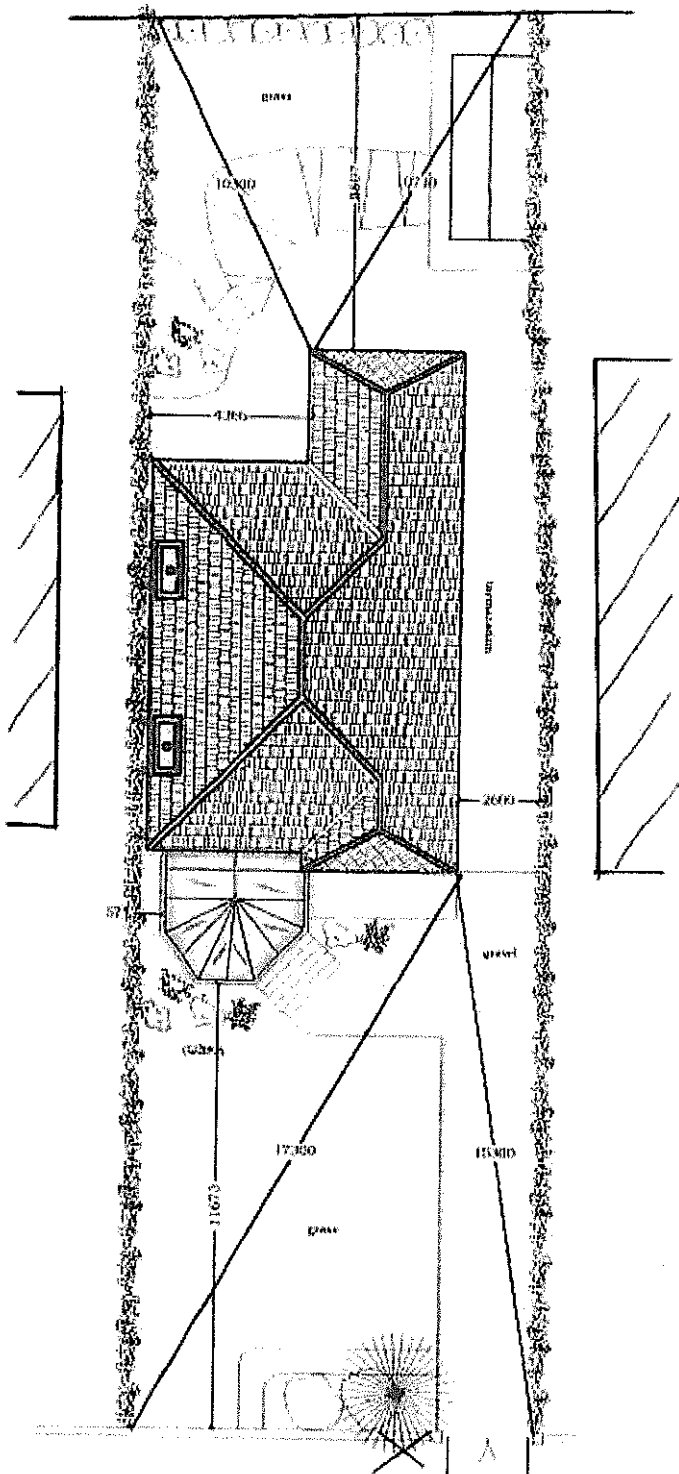

SITE NOTICE

BALLYHOOLY NEW ROAD



WISEMANSDESIGNS

ARCHITECTURAL CONSULTANCY

1 Lincoln Place , Grattan Hill , Cork , Ireland .

Tel/Fax. 00 353(0)21 4553644

wisemandesigns@eircom.net

DATE: 13 MAY 02
 DRAWN BY: A.W.
 CHECKED BY: A.W.
 PROJECT: Norv10-02-01/04

SCALE: 1:200

PROJECT: Norv10-02-01/04

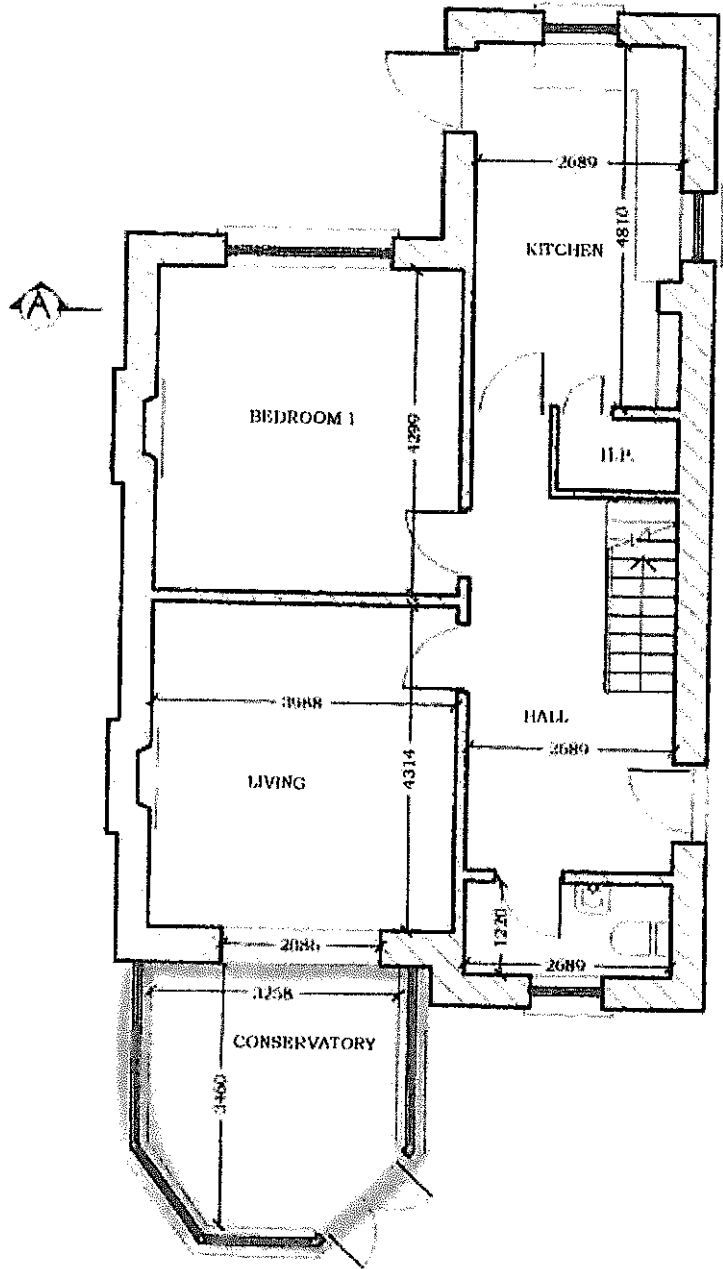
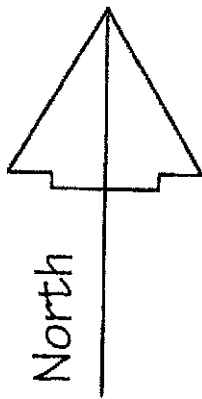

GROUND FLOOR PLAN

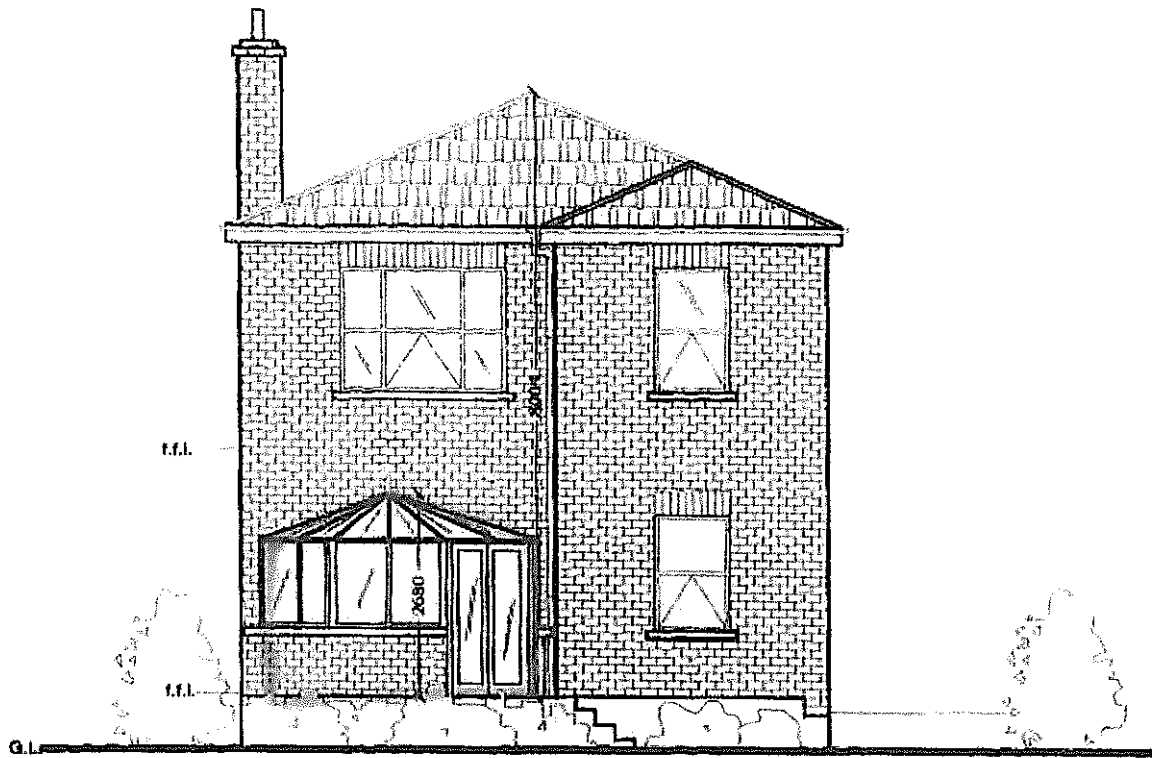

SOUTH ELEVATION

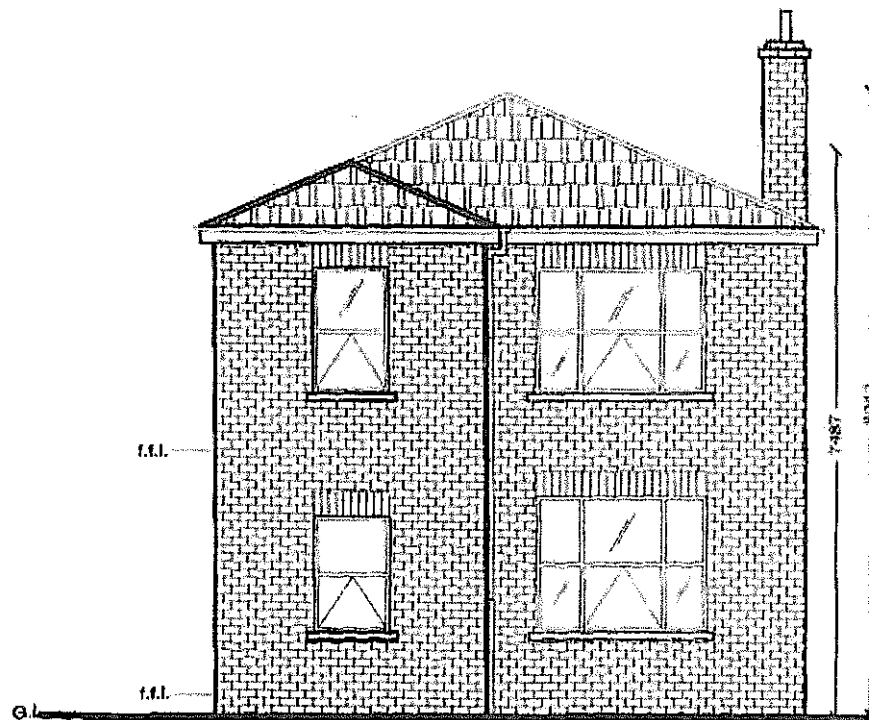

NORTH ELEVATION

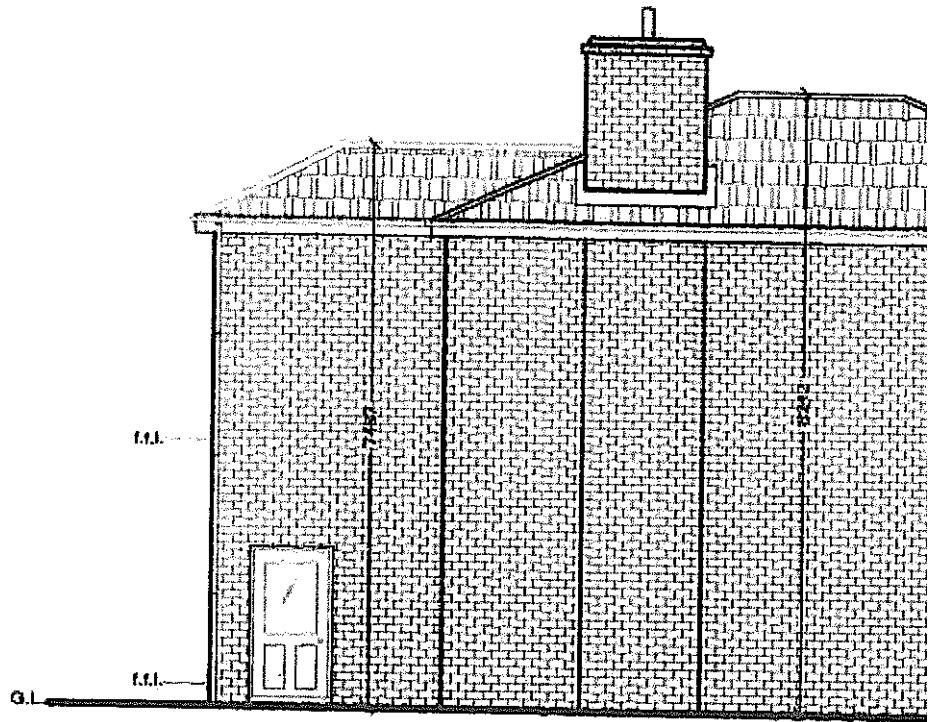

EAST ELEVATION

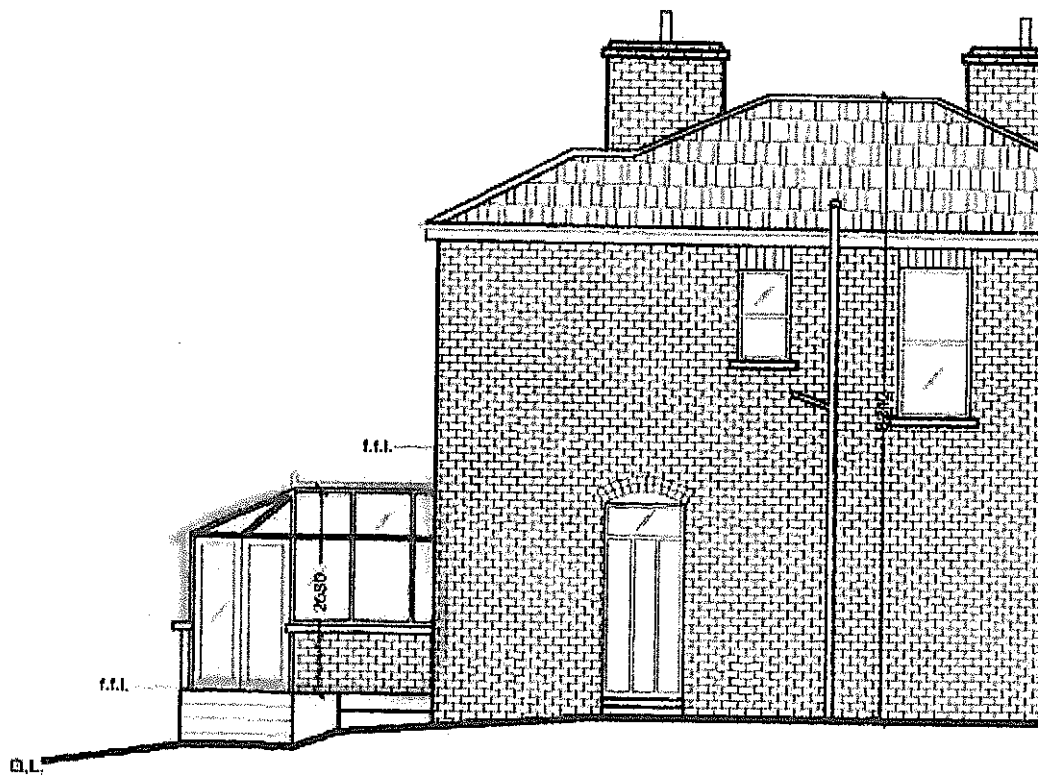

WEST ELEVATION

Comhairle Cathrach Chorcaí Cork City Council

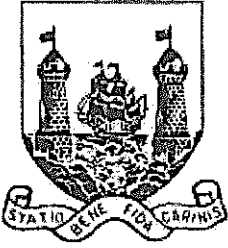

Fón/Tel: 021-4966222
Líonra/Web: www.corkcity.ie
R-Phost/E-mail: planning@corkcity.ie

Planning & Development Directorate
Navigation House,
Albert Quay,
Cork.

Ref

TO: Patrick Murphy
C/O Wiseman Designs
1 Lincoln Place
Grattan Hill
Cork

RE/ PLANNING AND DEVELOPMENT ACT 2000
NOTIFICATION OF FINAL GRANT

Planning Register Number: 02/26138
Valid Application Receipt Date: 24/05/2002

**In pursuance of the powers conferred upon them by the above mentioned Acts, Cork City Council have by Order dated 17/07/2002 GRANTED RETENTION to the above named, for the development of land, namely:-
Conservatory to the south elevation AT 'Norville' 42 Sidney Park Wellington Road subject to the 1 conditions set out in the schedule attached to said order.**

Signed on behalf of Cork City Council

Administrative Officer, Planning & Development

Date: 28/08/2002

COMHAIRLE CATHRACH CHORCAI - CORK CITY COUNCIL

PLANNING AND DEVELOPMENT ACT 2000

NOTIFICATION OF DECISION TO GRANT

PERMISSION

**SUBJECT TO CONDITIONS UNDER SECTION 34 OF THE ACT OF
2000**

TO: Mr. Patrick Murphy,
c/o Wiseman Designs,
1 Lincoln Place,
Grattan Hill,
Cork.

Reg No. T.P.02/26138

Application Received: 24/05/02

In pursuance of the powers conferred upon them by the above mentioned Acts, Cork City Council have by order dated *17th July 2002* decided to grant **PERMISSION** for the development of land, namely: **Permission for retention for conservatory to the south elevation located at no. 42 Sidney Park, Wellington Road, Cork.**

In accordance with plans and particulars submitted on 24/05/02

Subject to the conditions set out in Column 1 of the attached Schedule, for the reasons for the imposition of such conditions are set out in Column 2 of said Schedule.

If there is no appeal against said decision, a grant of **PERMISSION** in accordance with the decision, will be issued after the expiration of the period within which an appeal may be made to An Bord Pleanala (see footnote).

It should be noted that until a grant of **PERMISSION** has been issued, the development in question is **NOT AUTHORISED**.

NB. This permission is subject to 1 condition.

Signed on behalf of Cork City Council

Alex Bone

Staff Officer, Planning & Development Directorate.

Date: *17/7/02*

NB See Notes Overleaf.

Comhairle Cathrach Chorcaí Cork City Council



Fón/Tel: 021-4966222
Lionra/Web: www.corkcity.ie
R-Phost/E-mail: planning@corkcity.ie

Planning & Development Directorate
Navigation House,
Albert Quay,
Cork.

Ref

**Schedule of Conditions attached to
Planning Permission issued by Cork
City Council - Ref. T.P.02/26138**

Second Schedule

Column 1. Conditions	Column 2. Reasons For Conditions
----------------------	----------------------------------

1. The development shall be retained in accordance with the drawings and specifications submitted to the Planning Authority on 24/05/02 except where altered or amended by conditions in this permission.	1. To enable the Planning Authority to check the proposed development when completed.
---	---

ALL STRUCTURAL STEEL ELEMENTS TO BE DESIGNED BY A STRUCTURAL ENGINEER, ALL DIMENSIONS TO BE CHECKED ON SITE.

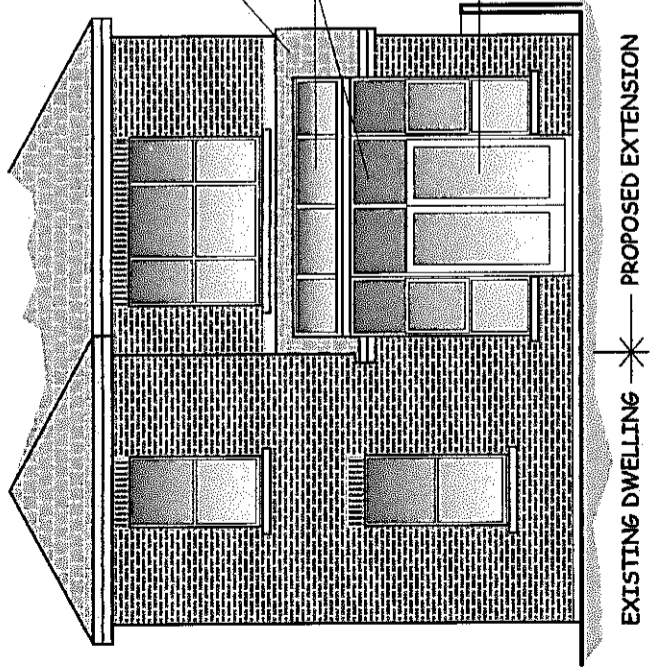

REAR ELEVATION

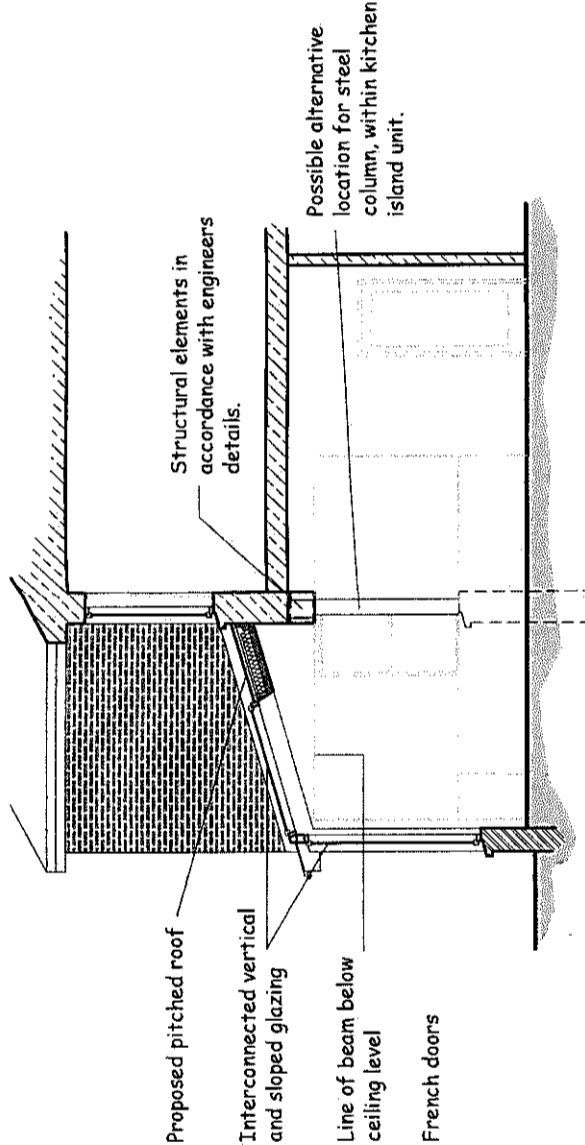

SIDE ELEVATION / SECTION

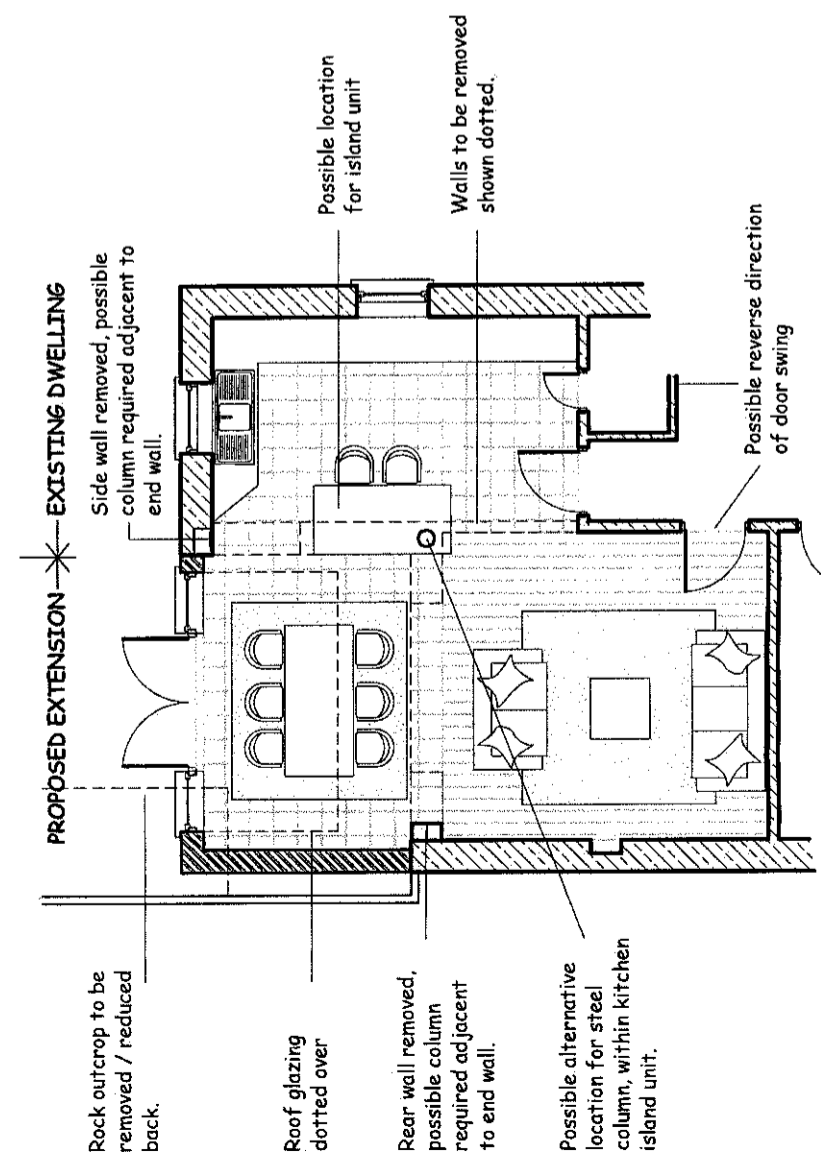

GROUND FLOOR PLAN

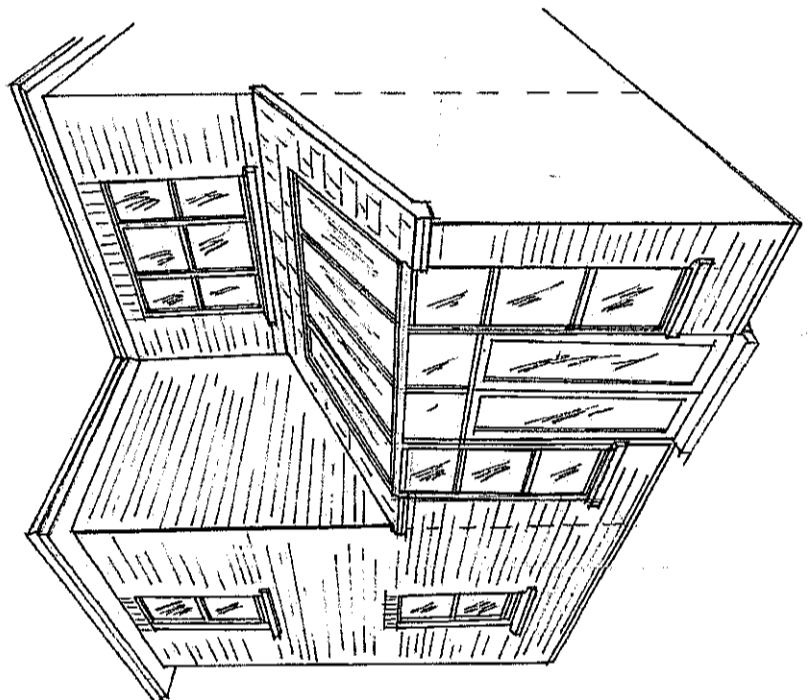

Perspective View From Rear

OPTION 2

PRELIMINARY ISSUE
6-6-2008

Revision:	
Client	Jean & Terry Canton
Project	Proposed Extension To Dwelling Norville Sidney Park Wellington Road Cork
Drawing Title	Preliminary Drawing
Scale: A3	Date: June 2008
1:100	Drawn: JOC
	Drawing No: 2008-2B
 MDD architects ARCHITECTURAL DESIGN, PLANNING CONSULTANTS, PROJECT MANAGEMENT. 43 Bank Place Malton, Co. Cork Tel: 022 554420 Fax: 022 554418 Web: www.mpp-architects.com	